

## User Manual



FC CE

### **MPW Series**

**7U Widescreen LCD Panel**

**Options Available:**

- SDI / MCS
- BNC / HDMI / Audio
- Touch-Screen / DC Power
- MIL-Type or Lockable Connector

Designed/Manufactured by Austin Hughes and Distributed by Eclipse Rackmount, Inc.

## Legal Information

First English printing, October 2002

Information in this document has been carefully checked for accuracy; however, no guarantee is given to the correctness of the contents. The information in this document is subject to change without notice. We are not liable for any injury or loss that results from the use of this equipment.

## Safety Instructions

**Please read all of these instructions carefully before you use the device. Save this manual for future reference.**

- Unplug equipment before cleaning. Don't use liquid or spray detergent; use a moist cloth.
- Keep equipment away from excessive humidity and heat. Preferably, keep it in an air-conditioned environment with temperatures not exceeding 40° Celsius (104° Fahrenheit).
- When installing, place the equipment on a sturdy, level surface to prevent it from accidentally falling and causing damage to other equipment or injury to persons nearby.
- When the equipment is in an open position, do not cover, block or in any way obstruct the gap between it and the power supply. Proper air convection is necessary to keep it from overheating.
- Arrange the equipment's power cord in such a way that others won't trip or fall over it.
- If you are using a power cord that didn't ship with the equipment, ensure that it is rated for the voltage and current labeled on the equipment's electrical ratings label. The voltage rating on the cord should be higher than the one listed on the equipment's ratings label.
- Observe all precautions and warnings attached to the equipment.
- If you don't intend on using the equipment for a long time, disconnect it from the power outlet to prevent being damaged by transient over-voltage.
- Keep all liquids away from the equipment to minimize the risk of accidental spillage. Liquid spilled on to the power supply or on other hardware may cause damage, fire or electrical shock.
- Only qualified service personnel should open the chassis. Opening it yourself could damage the equipment and invalidate its warranty.
- If any part of the equipment becomes damaged or stops functioning, have it checked by qualified service personnel.

## What the warranty does not cover

- Any product, on which the serial number has been defaced, modified or removed.
- Damage, deterioration or malfunction resulting from:
  - Accident, misuse, neglect, fire, water, lightning, or other acts of nature, unauthorized product modification, or failure to follow instructions supplied with the product.
  - Repair or attempted repair by anyone not authorized by us.
  - Any damage of the product due to shipment.
  - Removal or installation of the product.
  - Causes external to the product, such as electric power fluctuation or failure.
  - Use of supplies or parts not meeting our specifications.
  - Normal wear and tear.
  - Any other causes which does not relate to a product defect.
- Removal, installation, and set-up service charges.

## Regulatory Notices Federal Communications Commission (FCC)

This equipment has been tested and found to comply with the limits for a Class B digital device, pursuant to Part 15 of the FCC rules. These limits are designed to provide reasonable protection against harmful interference in a residential installation.

Any changes or modifications made to this equipment may void the user's authority to operate this equipment. This equipment generates, uses, and can radiate radio frequency energy and, if not installed and used in accordance with the instructions, may cause harmful interference to radio communications.

However, there is no guarantee that interference will not occur in a particular installation. If this equipment does cause harmful interference to radio or television reception, which can be determined by turning the equipment off and on, the user is encouraged to try to correct the interference by one or more of the following measures:

- Re-position or relocate the receiving antenna.
- Increase the separation between the equipment and receiver.
- Connect the equipment into an outlet on a circuit different from that to which the receiver is connected.

# Contents

## < Part. 1 > MPW-19

1.1	Package Contents	P.1
1.2	Structure Diagram & Dimensions	P.1 - 2
1.3	Installation	P.3

## < Part. 2 > Specifications / OSD / Remote Controller

2.1	Product Specifications	P.4 - 5
2.2	On-Screen Display Operation ( OSD )	P.6 - 7

## < Part. 3 > Options

3.1	3G / HD / SD- <b>SDI</b> Broadcast-grade input	P.8
3.2	<b>MCS</b> Multi-Display Control Solution	P.9
3.3	<b>AV2.2D</b> Upgrade : DVI-D + VGA + BNC + S-Video + Audio	P.10
3.4	<b>AV2.2H</b> Upgrade : HDMI + VGA + BNC + S-Video + Audio	P.10
3.5	19" Touch-Screen : Resistive, Capacitive	P.11
3.6	48V, 24V or 12VDC power	P.12
3.7	MIL-Type or Lockable Connector	P.13

## Before Installation

- It is very important to mount the equipment in a suitable cabinet or on a stable surface.
- Make sure the place has a good ventilation, is out of direct sunlight, away from sources of excessive dust, dirt, heat, water, moisture and vibration.

## Unpacking

The equipment comes with the standard parts shown in package content. Check and make sure they are included and in good condition. If anything is missing, or damaged, contact the supplier immediately.

## How To Clean Your LCD Monitor



### Caution :

- To avoid the risk of electric shock, make sure your hands are dry before unplugging your monitor from or plugging your monitor into an electrical outlet.
- When you clean your monitor, do not press down on the LCD screen. Pressing down on the screen can scratch or damage your display. Pressure damage is not covered under warranty.
- Use only cleansers made specifically for cleaning monitors and monitor screens. Cleansers not made to clean monitors and monitor screens can scratch the LCD display or strip off the finish.
- Do not spray any kind of liquid directly onto the screen or case of your monitor. Spraying liquids directly onto the screen or case can cause damage which is not covered under warranty.
- Do not use paper towels or abrasive pads to clean your monitor. Using an abrasive pad or any wood based paper product such as paper towels can scratch your LCD screen.

## Cleaning Your Monitor

To clean your LCD safely, please follow these steps :

- ① Disconnect the power cord.
- ② Gently wipe the surface using a clean, dry microfiber cloth. Use as little pressure as possible.

## Cleaning Tough Marks and Smudges

To remove tough marks and smudges, please follow these steps :

- ① Disconnect the power cord.
- ② Spray a small amount of non-abrasive cleanser on a microfiber cloth.



**Caution : Do not spray or apply any liquids directly onto the monitor. Always apply the solution to your microfiber cloth first, not directly on the parts you are cleaning.**

- ③ Gently wipe the surface. Use as little pressure as possible.
- ④ Wait until your monitor is completely dry before plugging it in and powering it up.

< Part 1 >

< 1.1 > Package Contents



**MPW-19 unit X 1**

- 6ft VGA cable X 1
- Power adapter X 1
- Power cord X 1

< 1.2 > Structure Diagram

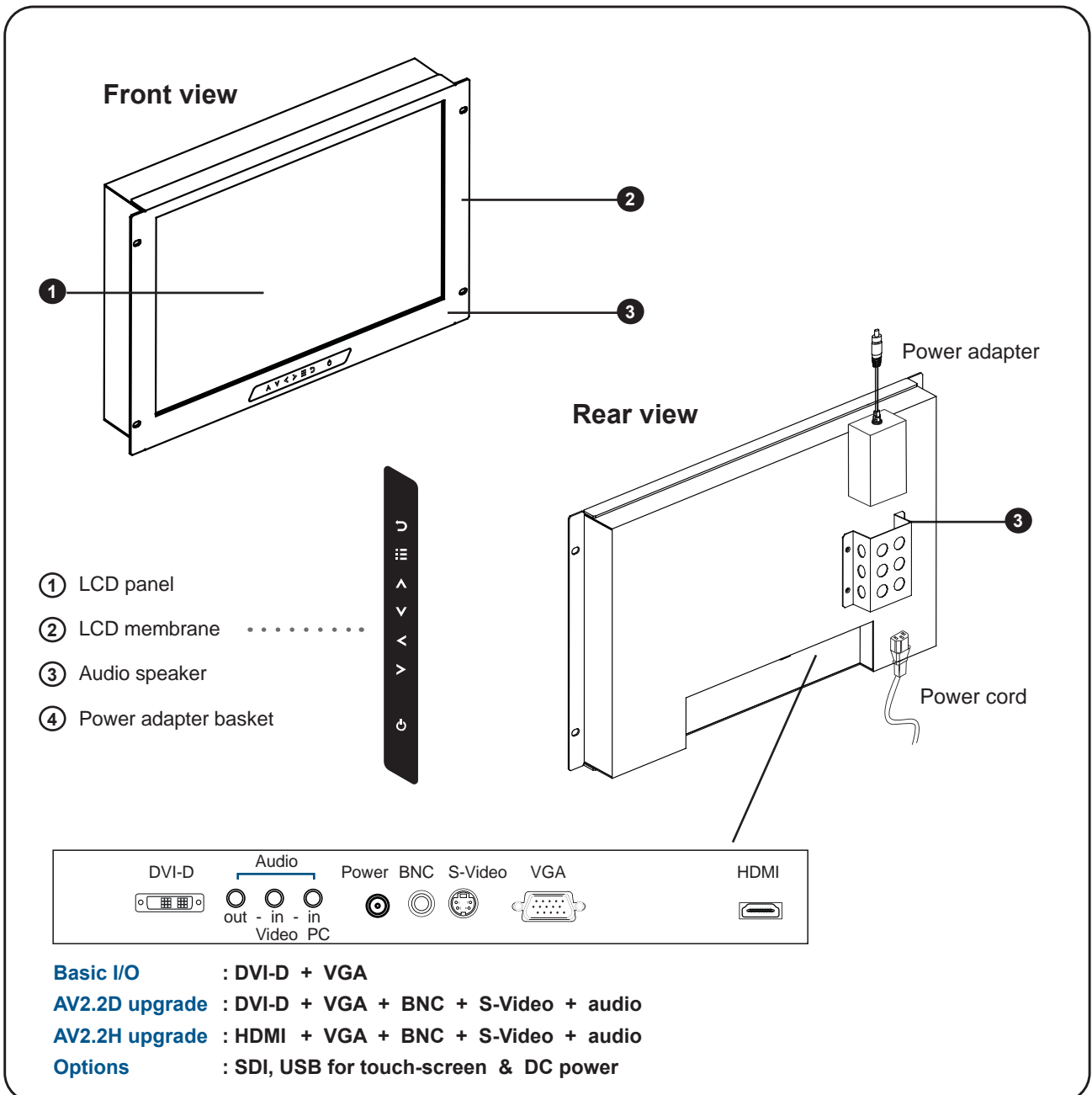

## < 1.2 > Dimensions

MPW-19

Front View

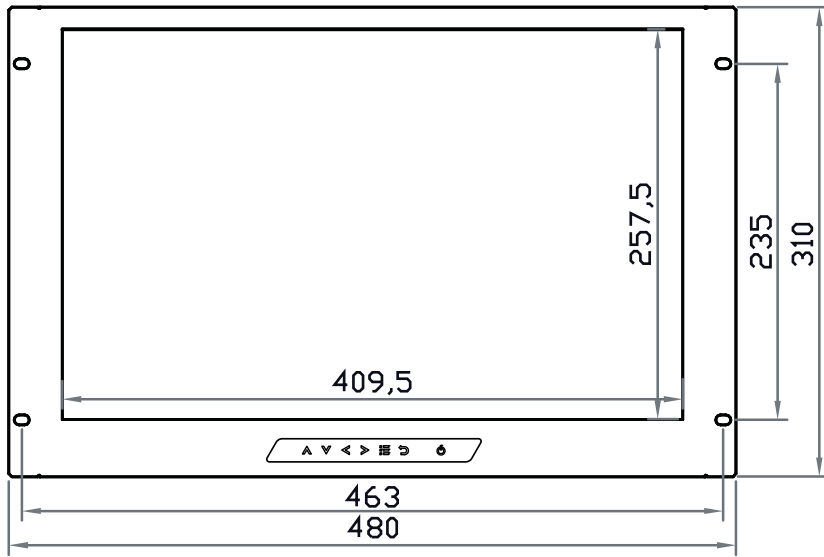

Side View



Bottom View

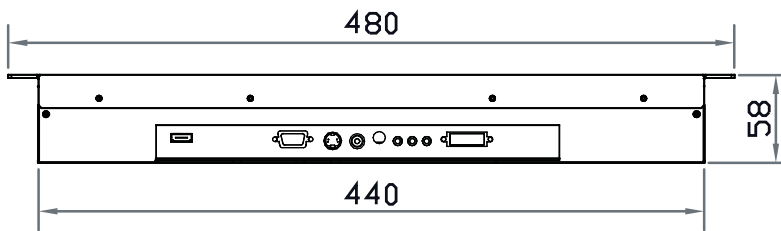

UNIT : mm

1mm = 0.03937 inch

Model	Product Dimension (W x D x H)	Packing Dimension (W x D x H)	Net Weight	Gross Weight
MPW-19	480 x 58 x 310 mm 18.9 x 2.3 x 12.2 inch	529 x 124 x 451 mm 20.8 x 4.9 x 17.8 inch	4.5 kg 9.9 lbs	6 kg 13.2 lbs

## < 1.3 > Installation

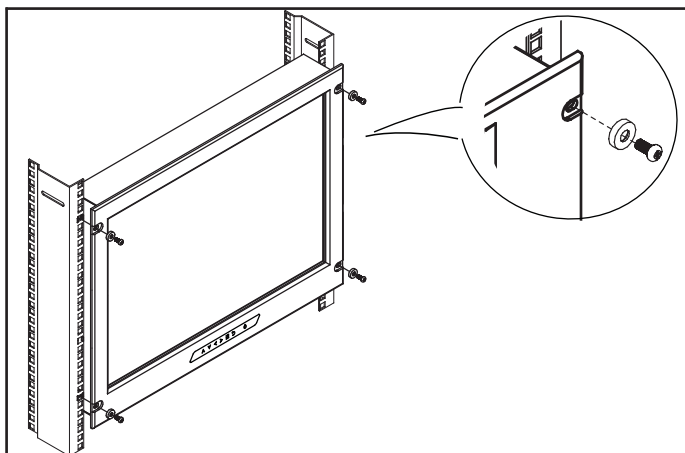

### Step 1

- Mount the display panel with M6 screw set.
- M6 screw x 4 pcs required ( Left & right side ).

**M6 screw sets are not provided.**

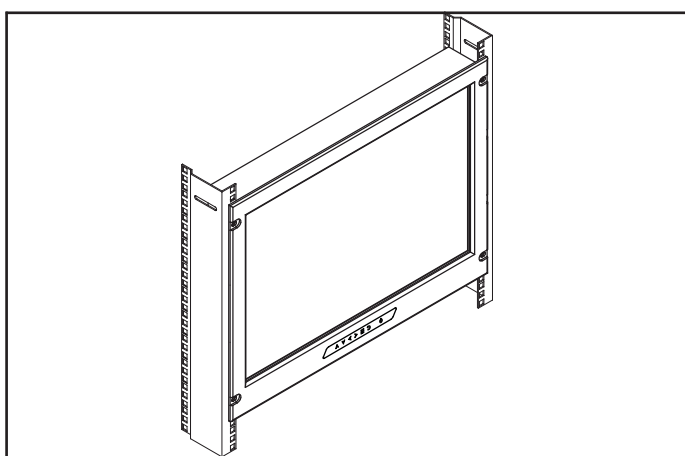

### Step 2

- Fix the LCD into the rack.

<b>LCD Panel</b>	Manufacturer	
	Panel Size ( diagonal )	19-inch Widescreen TFT color LCD
	Display pixel ( dots x lines )	1440 x 900
	Brightness ( typ. )	250
	Contrast Ratio ( typ. )	1000:1
	Color	16.7 M
	Viewing Angle ( L/R/U/D )	80/80/80/80
	Response Time ( ms )	5
	Dot pitch ( mm )	0.2835
	Display Area ( mm )	408.24H x 255.15V
	Surface treatment	Haze 25%, Hard-coating
	Surface hardness	3H
	Backlight Type	LED
	MTBF ( hrs )	30,000

<b>Video Connectivity</b>	Digital	HDMI	HDMI 1.1, CEA-861-D
		DVI	DVI-D, TMDS single link
	Analog	VGA	Analog 0.7Vp-p
		Composite ( BNC )	NTSC & PAL
		S-Video ( 4-pin )	NTSC & PAL
	Plug & Play	DVI / VGA	VESA EDID structure 1.3
	Synchronization	VGA	Separate, Composite & SOG

<b>Audio Connectivity</b>	Audio Input	Connector	3.5mm stereo jack
		Impedance / Power level	30kΩ / 750mV
	Audio Output	Connector	3.5mm stereo jack
		Resistance / Power level	30kΩ / 2.8V
	Speaker Output	Power	2 x 2W

\*When the audio output is connected, speaker output is OFF

<b>Power</b>	Power Supply	Range	Auto-sensing 100 to 240VAC, 50 / 60Hz
	Power Consumption	Screen display ON	25W or less
		Power saving mode	4W or less
		Power button OFF	1W or less

<b>Regulatory</b>	Safety Approval	FCC & CE
-------------------	-----------------	----------







<b>Environmental Conditions</b>	Operating	Temperature	0 to 50°C degree
		Humidity	20~90%, non-condensing
	Storage	Temperature	-5 to 60°C degree
		Humidity	5~90%, non-condensing
		Shock	10G acceleration (11ms duration)
		Vibration	5~500Hz 1G RMS random

<b>Physical Specification</b>	Product ( W x D x H )	480 x 58 x 310 mm 18.9 x 2.3 x 12.2 inch
	Packing ( W x D x H )	529 x 124 x 451 mm 20.8 x 4.9 x 17.8 inch
	Net Weight	4.5 kgs / 9.9 lbs
	Gross Weight	6 kgs / 13.2 lbs

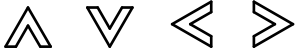

<b>Applicable Format</b>	DVI-D / VGA Input	PC Signal	1440 x 900 x 60Hz
			1280 x 1024 x 60 / 75Hz
			1280 x 960 x 60Hz
			1280 x 760 x 60 / 75Hz
			1152 x 864 x 75Hz
			1024 x 768 x 60 / 70 / 75Hz
			848 x 480 x 60Hz
			800 x 600 x 60 / 72 / 75Hz
			720 x 400 x 70Hz
			640 x 480 x 60 / 72 / 75Hz
			640 x 400 x 70Hz
640 x 350 x 70Hz			



Membrane Switch	Function
	Turn the monitor on or off
	Display the OSD menu Act as an Enter key to select screen setting options
	Scroll through menu options and adjust the displayed control
	Exit the OSD screen Go back to the previous on-screen sub-menu or main menu





Remark : All LED touch buttons in **WHITE** light.

The LED of **Power**  touch button will flash continuously when there is no signal input.

- ① All the LED touch buttons will automatically turn off after 10 minutes of idle status ( except the **Power**  ).
- ② Light up all membrane buttons, please press any button for 1 - 2 seconds ( except the **Power**  ).

## < 2.2 > On-Screen Display Operation ( OSD )

Ver: G56SN20SSTD701
1024 x 768 59.8Hz

**Image**

Brightness  50

Contrast  50

Color Temp    User

Red  255

Green  255

Blue  255

**OSD Conf guration Page**

---



**Image:**  
for the brightness, contrast, color temp, red, green, and blue

---



**Geometry:**  
for the auto adjust, H position, V position, phase and clock

---



**Video:**  
for the colour, tint, sharpness, noise reduction, DCDi and TV Setup

---



**Audio:**  
for volume, bass, treble, balance, AVL and mute

---



**Misc:**  
for the language, OSD position, graphic mode, ratio, reset and timer

< Part 3 >

< 3.1 > Options : 3G / HD / SD-SDI input

MPW-19



The SDI input is an ideal solution for the broadcast-grade video and high resolution CCTV market.

Designed for use with CyberView Full HD 1080p and ultra high resolution 1920 x 1200 LCD displays, the board provides an SDI input module without using additional space or power and it comes standard with a 2-year warranty.

**SDI**

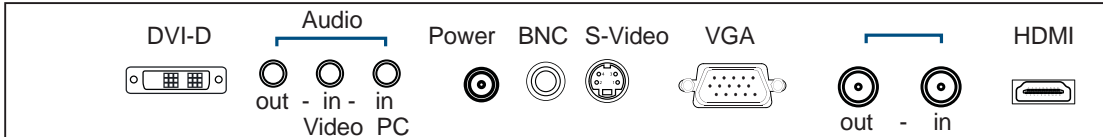

\*\*\* For **SDI** option, the AD board will be upgraded to AV3.0, and this comes standard with HDMI, DVI-D, VGA, S-Video, BNC and audio inputs.

<b>INPUT</b>	3G-SDI IN	BNC x 1 / 0.8Vp-p ( 75 ohm )
	3G-SDI OUT	BNC x 1 / Active through, equalized & relocked

<b>Standard Compliance</b>	Video	SMPTE 425M / 274M / 296M / 125M ITU-R BT.656
	Audio	SMPTE 299M / 272M-C

<b>Compatible Video Format</b>	3G-SDI	1080p @60 / 50Hz, 4:2:2
		1080p @30 / 25 / 24Hz, 4:4:4
		1080i @60 / 50Hz, 4:4:4
		720p @60 / 50Hz, 4:4:4
	HD-SDI	1080p @30 / 25 / 24Hz, 4:2:2
1080i @60 / 50Hz, 4:2:2		
720p @60 / 50Hz, 4:2:2		
SD-SDI	480i @60Hz, 4:2:2	
ITU-R BT.656	576i @50Hz, 4:2:2	

<b>Compatible Audio Format</b>	3G-SDI	48kHz, 16 / 20 / 24 bit, 2 CH, Synchronized Video
	HD-SDI	48kHz, 16 / 20 / 24 bit, 2 CH, Synchronized Video
	SD-SDI	48kHz, 16 / 20 / 24 bit, 2 CH, Synchronized / Asynchronized Video

<b>Max. Transmission Distance 75 ohm coaxial cable</b>	3G-SDI	150m at 2.97Gb/s
	HD-SDI	250m at 1.485Gb/s
	SD-SDI	480m at 270Mb/s

## < 3.2 > Options : MCS ( Multi-Display Control )



The MCS solution is able to control the OSD of various CyberView LCD displays up to 64 units.

The RS-232C is used for the communication between the PC and first display via a 15' serial cable, while the CAN bus is used for the LCD displays. They may be cascaded together via Cat 5/6 and daisy chained up to 1,000 meters.

Specifically designed for our displays, the MCS input module saves additional space/power and is covered by the 2-year standard warranty.

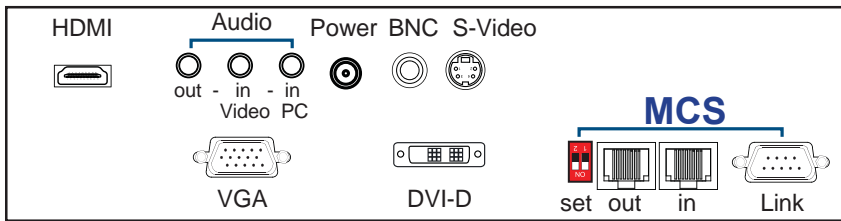

\*\*\* For additional information and specs on MCS, please contact your supplier.

\*\*\* For **MCS** option, casing depth will be changed.

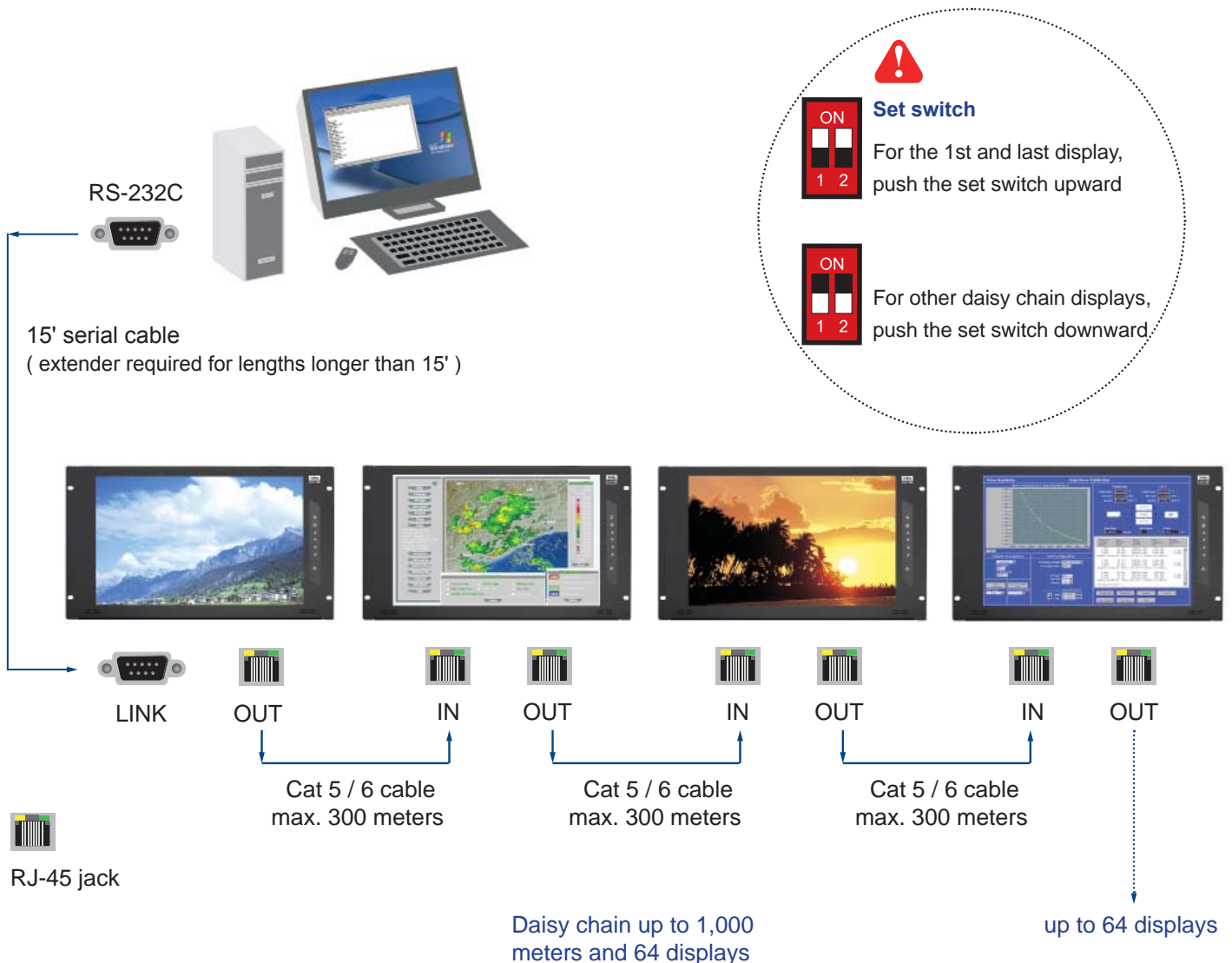

### < 3.3 > AV2.2D Upgrade Options :

MPW-19

- **DVI-D** ( DVI-D TMDS single link )
- **BNC** ( S-Video + Composite, BNC )
- **Audio** ( 3.5mm audio jacks for audio in & out, and 2W + 2W speakers )

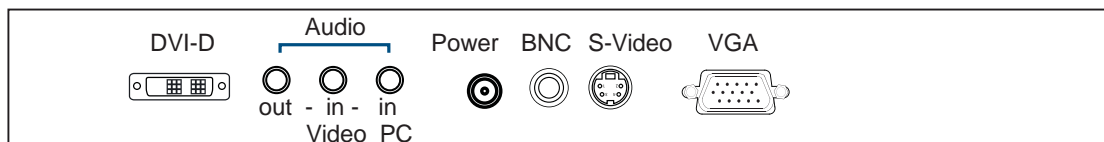

### < 3.4 > AV2.2H Upgrade Options :

- **HDMI** ( HDMI 1.1, CEA-861-D )
- **BNC** ( S-Video + Composite, BNC )
- **Audio** ( 3.5mm audio jacks for audio in & out, and 2W + 2W speakers )

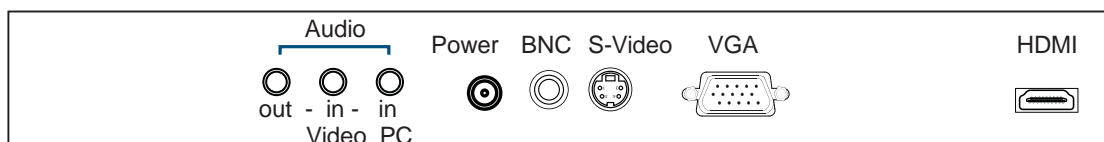

## < 3.3 > Options : Touch-Screen & Driver

### 19" USB Touch-Screen Specification

Model	TRB e-Resistive	TCB e-Capacitive
Technology	5-Wire Resistive	Capacitive
Touch Point	Single	Single
Method	Stylus or Finger	Finger
Activation Force	≤ 50g / Stylus=R0.8	≤ 50g
Durability	35 million touches	300 million touches
Response Time	15 ms	20 ms
Optical Transmittance	80% ± 3%	87% ±2%
Surface Hardness	3H	9H
Haze	8% ± 3%	7%
Glass	3.2 ±0.2 mm	2.8 mm ±10%
Connector	USB Type A	
Compatibility	Windows 7 / XP / Vista, Linux	

- USB touch-screen package includes 1 x 6ft USB cable, quick reference guideline and CD disc
- For detailed information, please refer to the attached CD disc
- As the touch-screen unit is not made of toughened glass, please handle it carefully

### USB Touch-Screen

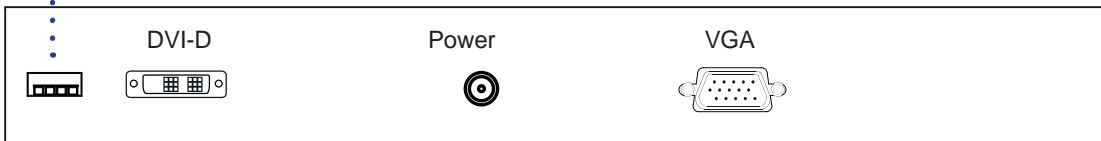

#### Please follow the below steps to setup the touch-screen:

- Step 1.** Run the bundled CD disc or download the driver from the link below :  
<http://www.austin-hughes.com/downloads/RMDL/software.html>
- Step 2.** Double click the Setup.exe
- Step 3.** Follow the installation instruction to finish the setup
- Step 4.** After installation, run the TouchKit program & the “4 point calibration”



Please do the initial calibration after the first setup

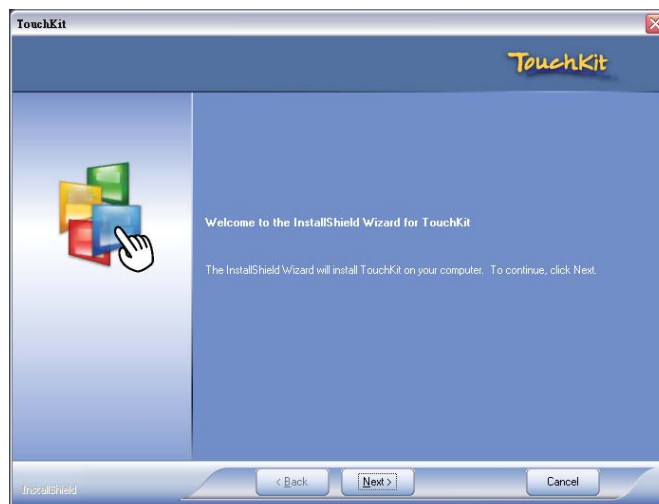

### < 3.4 > Options : DC Power

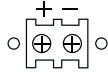

MPW-19



Model	12V	24V	48V
<b>Input rating</b>			
Input voltage:	12-Volt	24-Volt	48-Volt
Input range:	9 ~ 18V	18 ~ 36V	36 ~ 75V
Input current			
- No load	50 mA	50 mA	50 mA
- Full load	4950 mA	2450 mA	1220 mA
<b>Output rating</b>			
Output voltage:	12-Volt	12-Volt	12-Volt
Output current:	4.16A	4.16A	4.16A
<b>Efficiency</b>	84%	85%	85%



### < 3.5 > Options : MIL-Type or Lockable Connector

	Input	Part no.	MIL Standard
<b>MIL - type Connector</b>	DC Power *** ( Male )	MS3470W8-33P 	MIL - DTL - 26482
	VGA *** ( Male )	MS3470W14-15P 	MIL - DTL - 26482

\*\*\* There are several additional MIL DC and VGA connector types with varying design characteristics to meet cost considerations and to provide users with the most design flexibility possible. For more information, please contact your supplier.

	Input	Part no.	Standard
<b>Lockable Connector</b>	DC Power ( Male )	YM-Ext-461CP001 	D-type 3W3
	USB	LUSB - A111 - 00 	-

\*\*\* MIL - Type or lockable connectors above can be integrated with our LCD displays. Connectors are not available independently

The company reserves the right to modify product specifications without prior notice and assumes no responsibility for any error which may appear in this publication.

All brand names, logo and registered trademarks are properties of their respective owners.

Copyright 2013 Austin Hughes Electronics Ltd. & Eclipse Rackmount, Inc. All rights reserved.